

► Standard engines

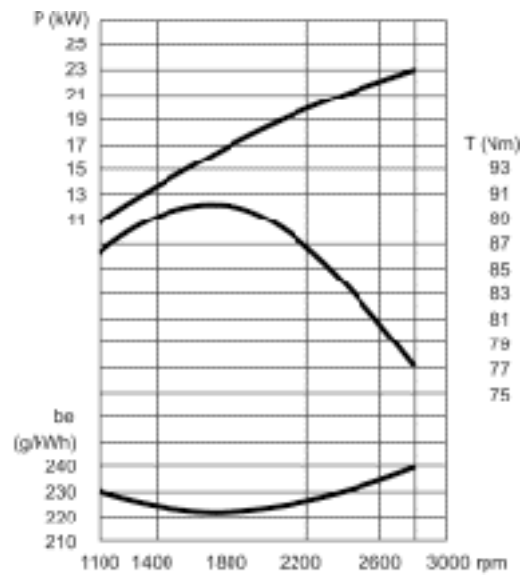

► F2.2011

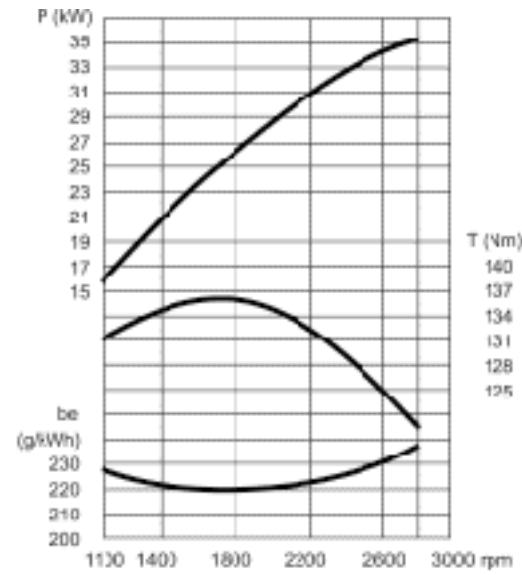

► F3.2011

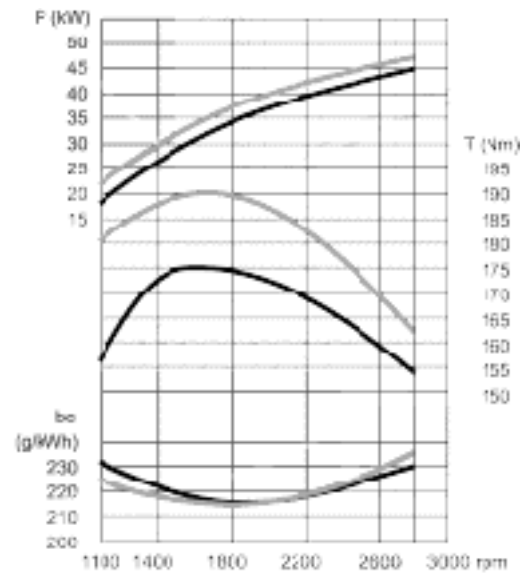

► BF3L2011

► F4L2011

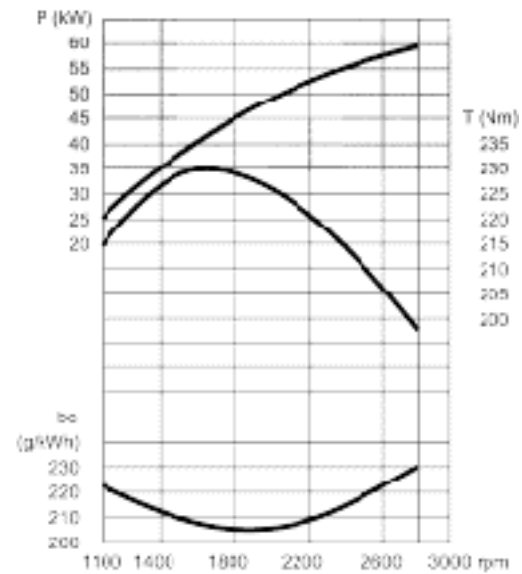

► BF4L2011



2011. The engine for construction.

12 - 58.1 kW at 1500 - 2800 rpm



Best.-Nr. 00311963 / 04 / 00 / MM-V



Engines with integrated cooling system.

These are the characteristics of the 2011:

- 2-, 3- and 4-cylinder naturally aspirated in-line engines.
- 3- and 4-cylinder engines also turbocharged.
- Integrated cooling system (engine is supplied complete with heat exchanger).
- Cooling and lubrication with oil.
- 14% more power output in comparison to the successor 1011F.
- 100% extended belt change interval.
- PTO for hydraulic pump drive is increased by 55%.
- All service points on one engine side.
- Compact engine design.

Your benefit:

- Designed specifically for construction equipment the dimensions of the engines are extremely compact. Thus reducing installation costs.
- The new engines, which display an exceptional power /weight ratio, perform brilliantly while at the same time complying with the stricter regulations on environmental protection.
- Cooling and lubrication with oil avoid corrosion and cavitation. High reliability combined with long maintenance intervals and less wear parts.
- Low noise emission, no expensive insulation measures for noise reduction.



Knowing it's DEUTZ.

DEUTZ AG
 Deutz-Mülheimer Str. 147-149
 D-51057 Köln
 Telefon: ++ 49 (0) 2 21-8 22-25 10
 Telefax: ++ 49 (0) 2 21-8 22-25 29
 Internet: <http://www.deutz.de>

► Engine Description

Type of cooling:	Integrated oil cooling
Crankcase:	Grey cast iron
Crankcase breather:	Closed-circuit breather
Cylinder head:	Block-type cast iron cylinder head
Valve arrangement/ Timing:	Overhead valves in cylinder head, one inlet and one exhaust valve per cylinder, actuated via tappets, push rods and rocker arms, driven by toothed belt and camshaft, automatic tensioner.
Piston:	Three-ring piston, two compressions rings and one oil scraper ring
Piston cooling:	Oil-cooled with spray nozzles
Connecting rod:	Drop-forged steel rod
Crankshaft and big-end bearings:	Ready-to-install plain bearings
Crankshaft:	Modular cast iron
Camshaft:	Steel shaft in bi-metal bearings
Lubrication system:	Forged-feed circulation lubrication with rotary pump which feeds both lubrication and cooling systems (and cab heating if fitted)
Lube oil cooler:	Integrated, of light metal
Lube oil filter:	Paper-type micro-filter as replaceable cartridge full flow filter
injection pump/ Governor:	Single injection pumps with mechanical centrifugal governor
Fuel lift pump:	Serviceable, with integrated strainer
injection nozzle:	Five-hole nozzle
Fuel filter:	Replaceable cartridge
Alternator:	Three-phase alternator, 14 V; 60 A (Standard)
Starter motor:	2,3 kW; 12 V
Heating system:	Optional connection for cab heating
Options:	Intake manifold connections, exhaust manifolds connections, hydraulic pumps, engine mounts rigid and flexible, oil pans, dipsticks, SAE 3/4/5/6 flywheel housings, alternators 12 and 24 V, oil filter positions horizontal and vertical, oil filler neck on side of crankcase or cylinder head cover

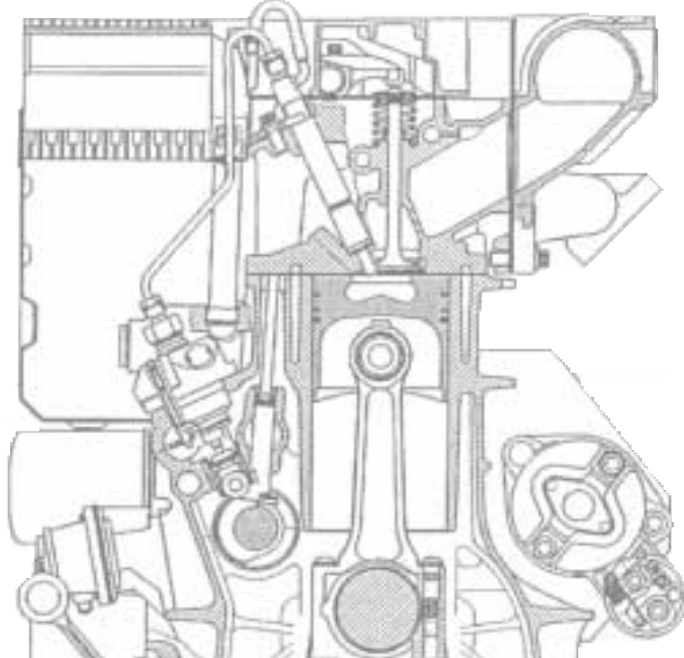

► Technical Data

Engine type		F2L2011	F3L2011	BF3L2011	F4L2011	BF4L2011
Numer of cylinder		2	3	3	4	4
Bore/stroke	mm	94/112	94/112	94/112	94/112	94/112
Displacement	l	1.55	2.33	2.33	3.11	3.11
Compression ratio		18.5	18.5	17.5	18.5	17.5
Max. rated speed	rpm	2800	2800	2800	2800	2800
Mean piston speed	m/s	10.45	10.45	10.45	10.45	10.45
Power ratings for construction equipment engines ⁴⁾						
Power ratings for automotive- and industrial engines ²⁾	kW	23.0	35.8	44.9	47.8	58.1
at speed	rpm	2800	2800	2800	2800	2800
Mean effective pressure	bar	6.36	6.58	8.26	6.59	8.01
Power ratings for cont. operation ³⁾	kW	21.8	34.0	42.6	45.4	55.1
at speed	rpm	2800	2800	2800	2800	2800
Mean effective pressure	bar	6.03	6.25	7.83	6.26	7.60
Max. torque	Nm	90	137	176	190	230
at speed	rpm	1700	1700	1600	1700	1600
Minimum idle speed	rpm	900	900	900	900	900
Specific fuel consumption ⁴⁾	g/kWh	220	218	212	214	205
Weight to DIN 70020, Part 7A ⁵⁾	kg	175	216	221	254	255

► Dimensions

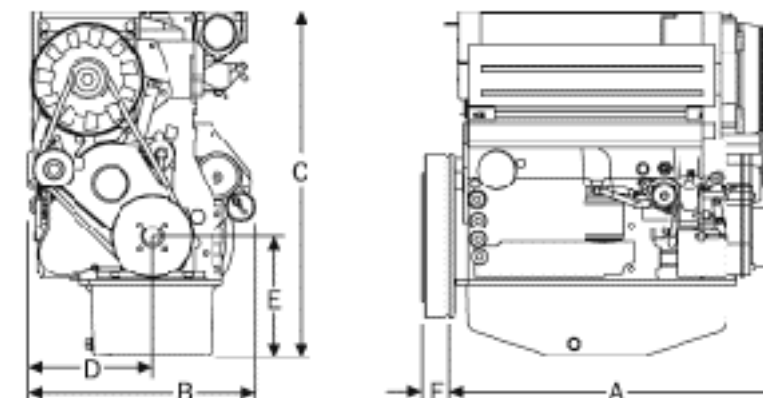

Engine type		A	B	C*	D	E	F
F2L2011	mm	407	451	683	243	225	80
F3L2011	mm	519	451	678	243	220	80
BF3L2011	mm	519	495	678	343	220	93
F4L2011	mm	630	451	703	243	245	80
BF4L2011	mm	630	495	703	243	245	80

► Model designation

BF 4 L 2011

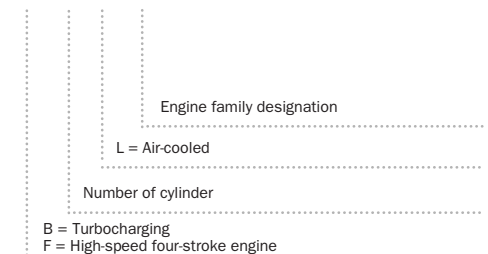

- 1) Power ratings at flywheel net, incl. integrated cooling system.
- 2) For intermittent operation to ISO 3046-1/ISO 1585.
- 3) Fuel stop power acc. to 3046/1 (ICFN).
- 4) At optimal operating point. Specific fuel consumption based on diesel fuel with a specific gravity of 0.835 kg/dm³ at 15°C.
- 5) Including integrated cooling system, dry weight.
* With standard oil pan.

The values given in this data sheet are for information purposes only and not binding. The information given in the offer is decisive.